

# Brompton Specification

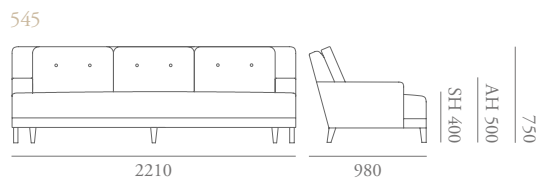

*Designed by Katerina Zachariades*

The Brompton collection offers contemporary upholstered detailing with a traditional touch, including lounge chairs, sofas and modular seating. A block like form is softened with radiused upholstered corners and a seam that divides the back enhancing the lumbar support. The armchair features an optional timber back detail. The larger sofas have separate back cushions and are also available as a modular system.

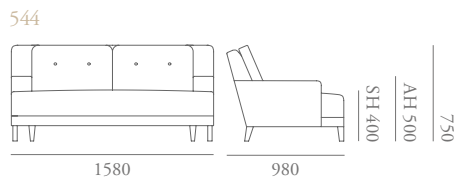
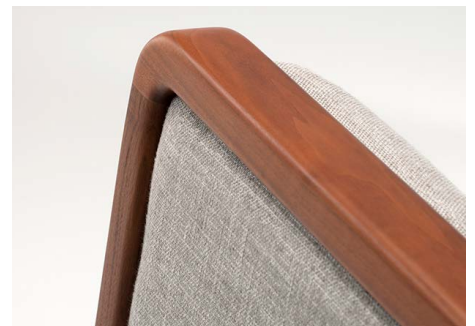
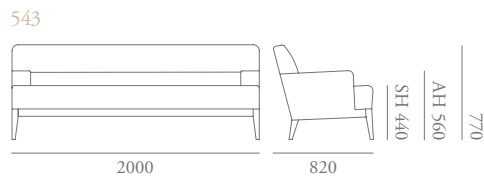
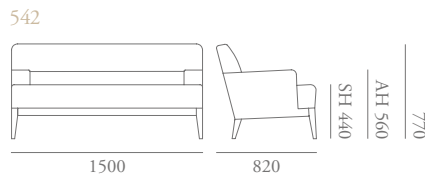
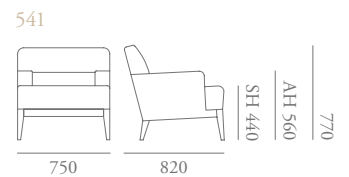
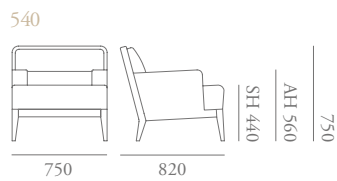

# Brompton Specification



## Modular Systems

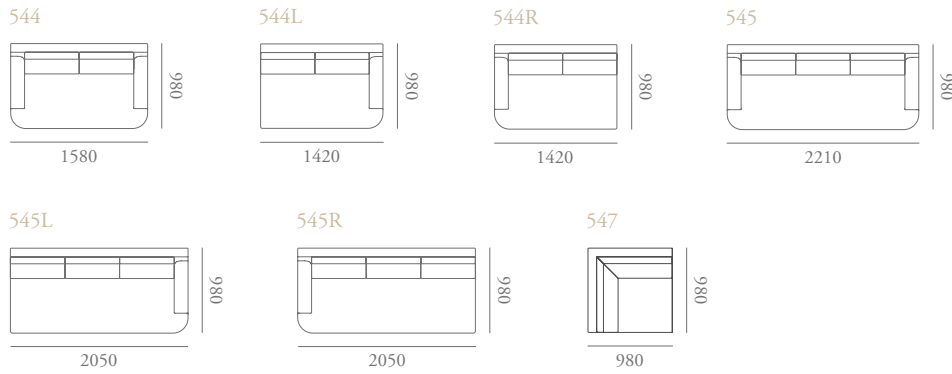

## Example Configurations

