

# Valencia Specification



*Designed by Morgan Studio*

The Valencia collection is a modular system of seating, which intersects to form multi-directional seating grids. The sharp and dramatic profile is available as a full back, 3/4 back or 1/2 back module. Between modules, a sculptural 'V' shaped gap is created. All modules below are shown as 'R' right arm, but can be 'L' left arm.

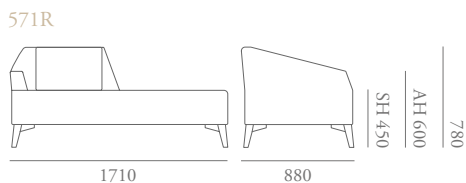
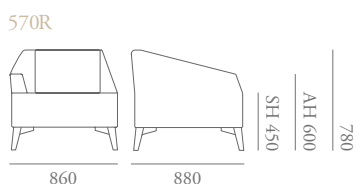
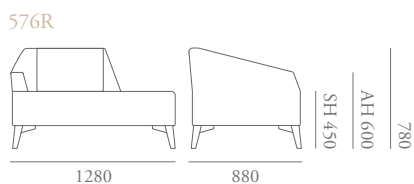
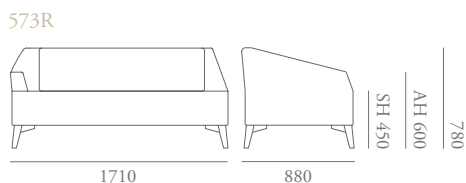
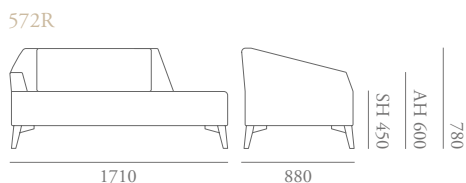
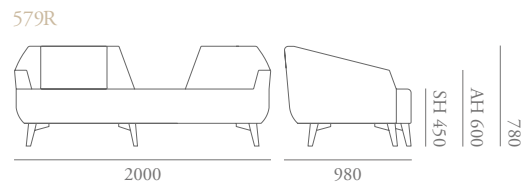
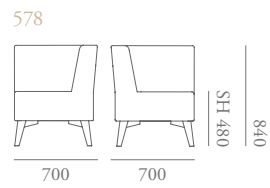
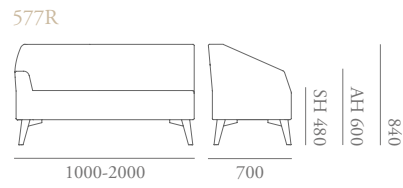
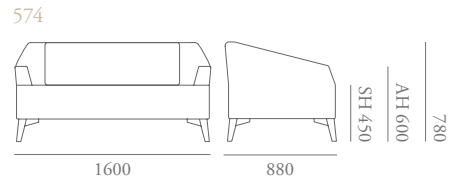

Table feature available, as 571RT



# Valencia Specification



# Valencia Specification



## Modular Systems

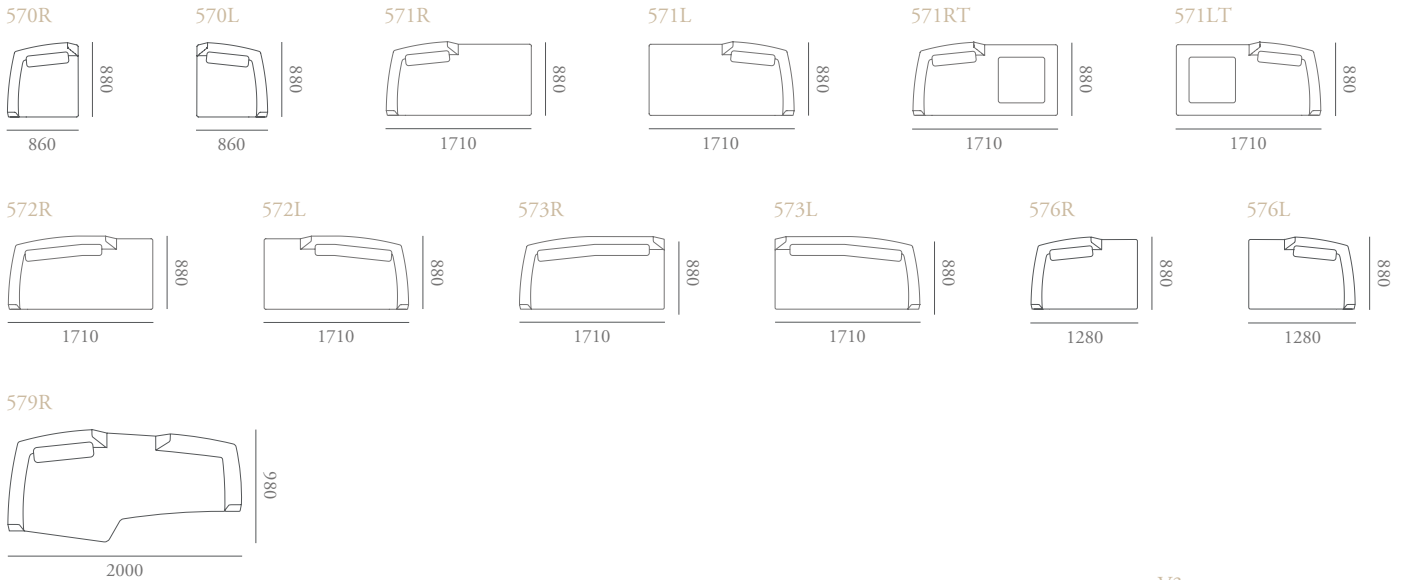

## Example Configurations

